

**ASSEMBLY INTRUCTIONS**

**PARGA DINNING TABLE**  
D 120 X 73CM

**BUYER :**  
BRAIFAB

**POST**

**QTY**

**COMPONENT**

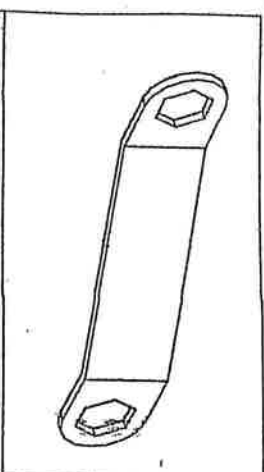
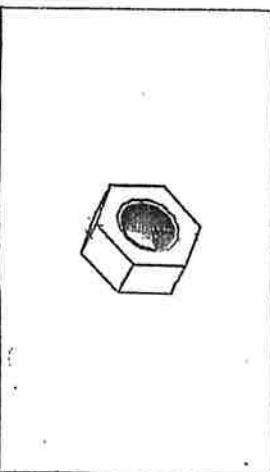
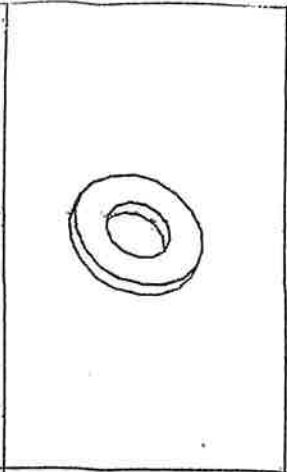
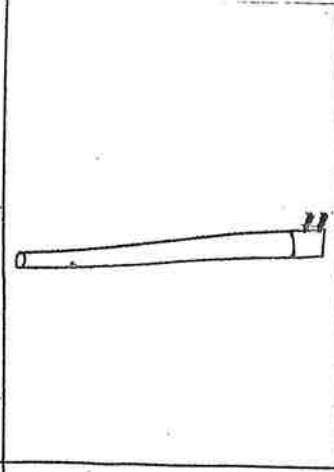
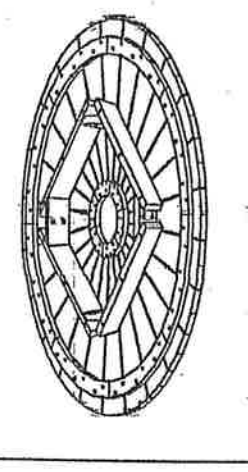
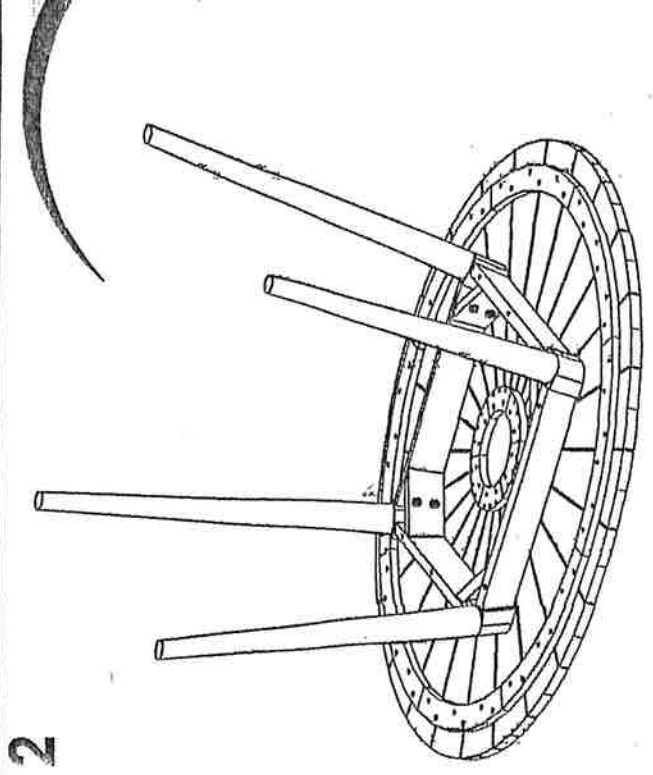
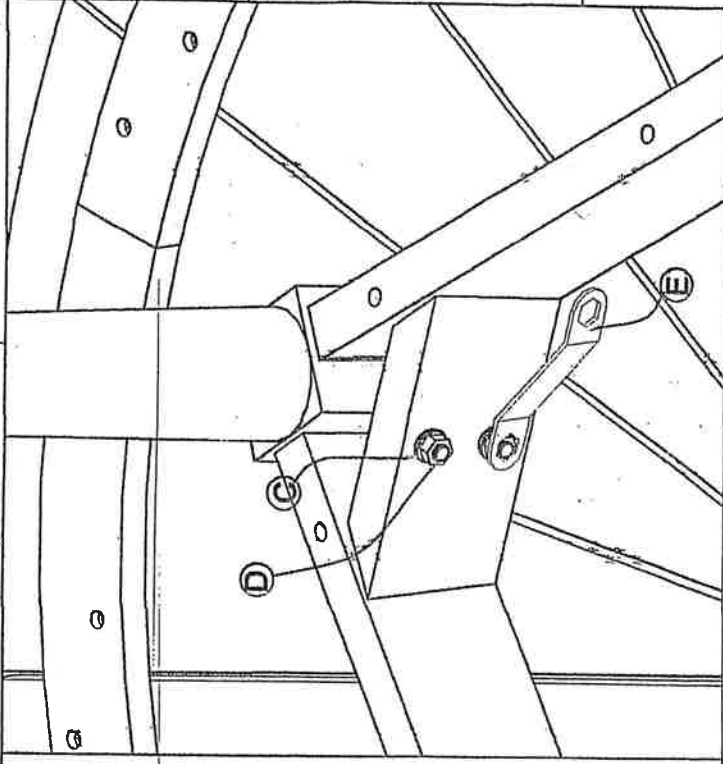
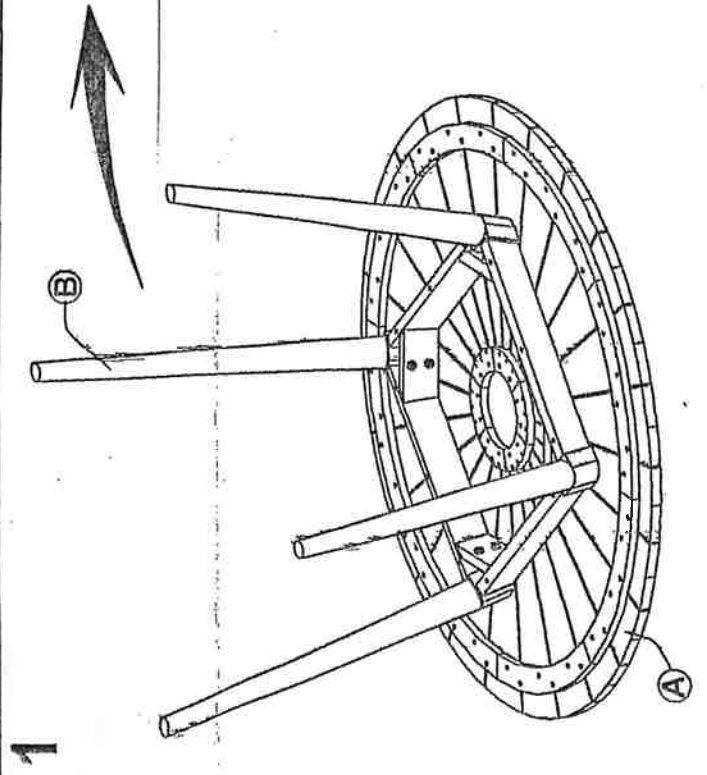

A 1

B 4

C 8

D 8

E 1