

4217 Leone bord monteringsanvisning

(3)

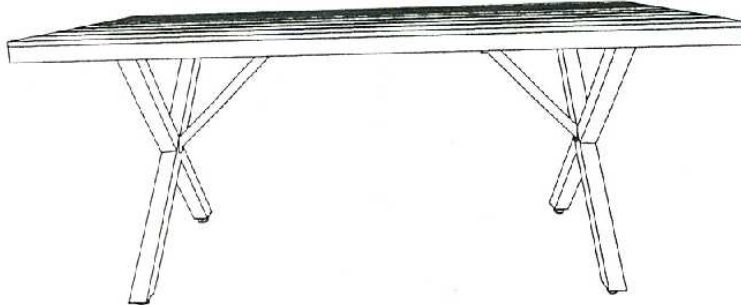

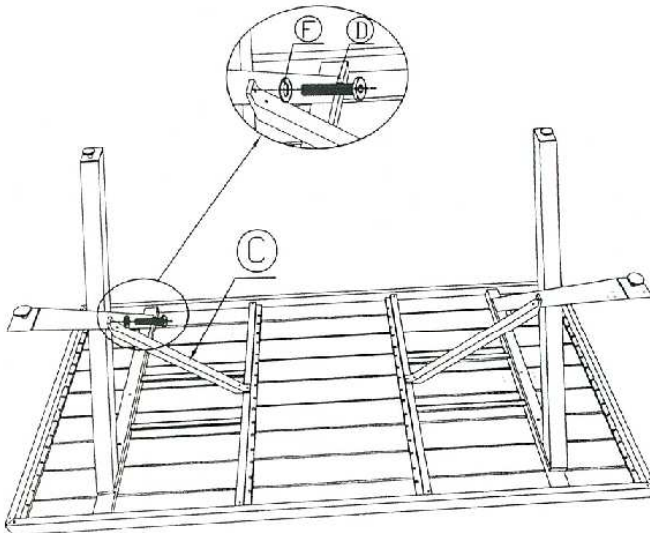





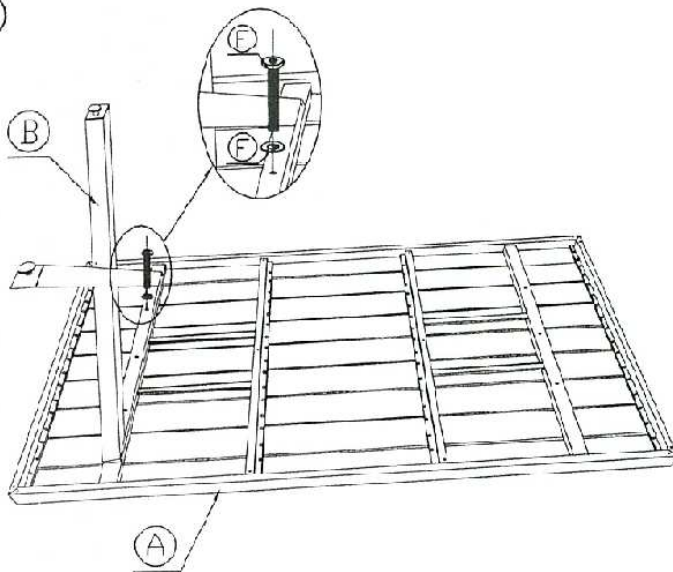

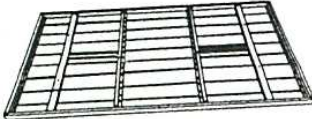
(2)



(1)



(A)		1
(B)		2
(C)		2
(D)	 M6*20	4
(E)	 M6*35	6
(F)		10
(G)		4
(H)		1